

# SA's Leading Past Year

## Exam Paper Portal



You have Downloaded, yet Another Great Resource to assist you with your Studies 😊

Thank You for Supporting SA Exam Papers

Your Leading Past Year Exam Paper Resource Portal

Visit us @ [www.saexampapers.co.za](http://www.saexampapers.co.za)



**SA EXAM  
PAPERS**  
SA EXAM  
PAPERS



**basic education**  
 Department:  
 Basic Education  
 REPUBLIC OF SOUTH AFRICA

Candidate Barcode label/Stafieskodeplakker

SC/NSC Answer Book  
 SS/NSS-antwoordeboek

Senior Certificate/National Senior Certificate/Senior Sertifikaat/Nasionale Senior Sertifikaat (Grade 12/Graad 12) 2024  
 Confidential/Vertroulik

CENTRE NUMBER SENTRUMNUMMER									
--------------------------------	--	--	--	--	--	--	--	--	--

EXAMINATION NUMBER EKSAMENNUMMER													
-------------------------------------	--	--	--	--	--	--	--	--	--	--	--	--	--

DATE DATUM							
---------------	--	--	--	--	--	--	--

BOOK NUMBER BOEKNUMMER		OF VAN		BOOKS BOEKE	
---------------------------	--	-----------	--	----------------	--

SUBJECT CODE VAKKODE					
-------------------------	--	--	--	--	--

PAPER NUMBER VRAESTELNUMMER	2
--------------------------------	---

SUBJECT NAME VAKNAAM	<b>TECHNICAL MATHEMATICS/TEGNIESE WISKUNDE</b>
-------------------------	--

MARKER/NASIENER			MODERATOR'S INITIALS IN RELEVANT BLOCK/ MODERATORPARAAF IN BETROKKE BLOKKIE					
Question Vraag	Marks Punte	Marker's Code & Initials	Marks Punte	SM	DCM	CM	IM	EM
1								
2								
3								
4								
5								
6								
7								
8								
9								
10								
11								
12								
13								
14								
15								
16								

RE-MARK/RE-CHECK/ HERNASIEN/HERKONTROLEER		
Question Vraag	Marks Punte	Initials Paraaf
1		
2		
3		
4		
5		
6		
7		
8		
9		
10		
11		
12		
13		
14		
15		
16		

				<b>TOTAL TOTAAL</b>				

				<b>TOTAL TOTAAL</b>
				<b>HASH TOTAL RAFTOTAAL</b>

CONTROLLED AND CERTIFIED CORRECT SURNAME AND INITIALS OF EA)	
---	--

PLEASE READ INSTRUCTIONS ON THE NEXT PAGE  
 LEES ASSEBLIEF INSTRUKSIES OP VOLGENDE BLADSY

This answer book consists of 25 pages./Hierdie antwoordeboek bestaan uit 25 bladsye.



PLEASE FOLLOW THESE INSTRUCTIONS CAREFULLY	VOLG ASSEBLIEF HIERDIE INSTRUKSIES NOUKEURIG
<p>1. Your examination number and centre number must be clearly written in the space provided and attach your examination number sticker in the space provided.</p> <p>2. Remember that your own name (or the name of your school) may not appear anywhere on or in this answer book.</p> <p>3. Answer ALL questions in the spaces provided.</p> <p>4. No pages may be torn from this answer book.</p> <p>5. Read the instructions printed on your timetable carefully as well as any other instructions which may be given in each examination paper.</p> <p>6. Candidates may not retain an answer book or remove it from the examination room. Answer books must be returned to the Invigilator at the end of the examination session.</p> <p>7. Answers must be written in black/blue ink as distinctly as possible. Do NOT write in the margins.</p> <p>8. Indicate the questions you have answered by drawing a circle around the relevant numbers on the front cover of the answer book where marks are to be recorded.</p> <p>9. Draw a line through any work/rough work that must not be marked.</p> <p>10. In the event that you use the additional space provided:  10.1 Write down the question number question.  10.2 Leave a line and rule off after your answer.</p>	<p>1. Skryf jou eksamennommer en sentrumnommer duidelik in die ruimtes verskaf en plak jou eksamennommeretiket in die ruimte verskaf.</p> <p>2. Onthou dat jou eie naam (of die naam van jou skool) nie op of in hierdie antwoordeboek mag voorkom nie.</p> <p>3. Beantwoord ALLE vrae in die ruimtes wat verskaf is.</p> <p>4. Geen bladsye mag uit hierdie antwoordeboek geskeur word nie.</p> <p>5. Lees die instruksies wat op jou eksamenrooster gedruk is sorgvuldig deur, asook enige ander instruksies wat in elke eksamen vraestel gegee word.</p> <p>6. Geen antwoordeboek mag deur die kandidaat behou of uit die eksamenlokaal verwyder word nie. Antwoordeboeke moet aan die einde van die eksamensessie aan die toesighouer terugbesorg word.</p> <p>7. Skryf die antwoorde so duidelik moontlik met swart/blou ink. MOENIE in die kantlyn skryf NIE.</p> <p>8. Dui die vrae wat jy beantwoord het op die voorblad van die antwoordeboek aan, waar die punte aangebring word, deur 'n kringetjie om die nommers van die vrae wat jy beantwoord het, te trek.</p> <p>9. Trek 'n netjiese lyn deur enige werk/rofwerk wat nie nagesien moet word nie.</p> <p>10. In geval jy die bykomende ruimte wat verskaf is, gebruik:  10.1 Skryf die vraagnommer neer.  10.2 Laat 'n lyn oop en trek 'n lyn na jou antwoord.</p>



**QUESTION/VRAAG 1**

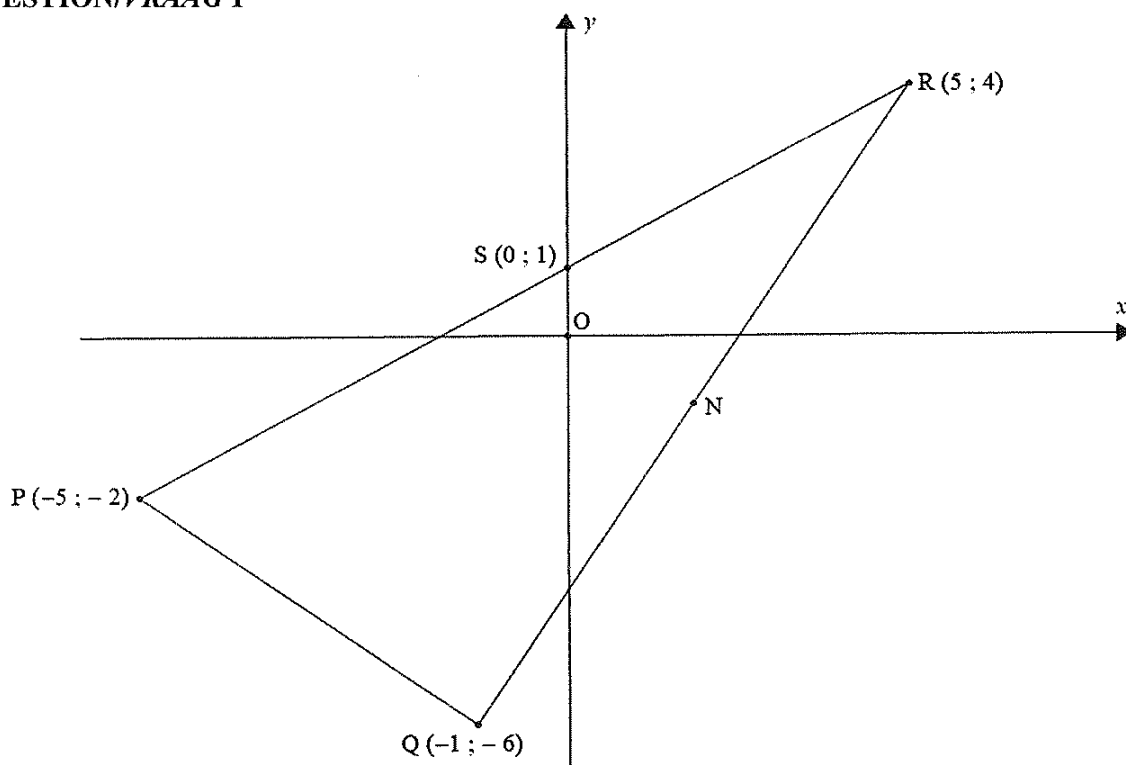

	<b>Solution/Oplissing</b>	<b>Marks Punte</b>
1.1.1		(2)
1.1.2		(2)
1.1.3		(3)

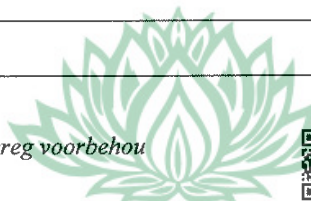

	Solution/Oplissing	Marks Punte
1.2		
		(4)
		[11] -



**QUESTION/VRAAG 2**

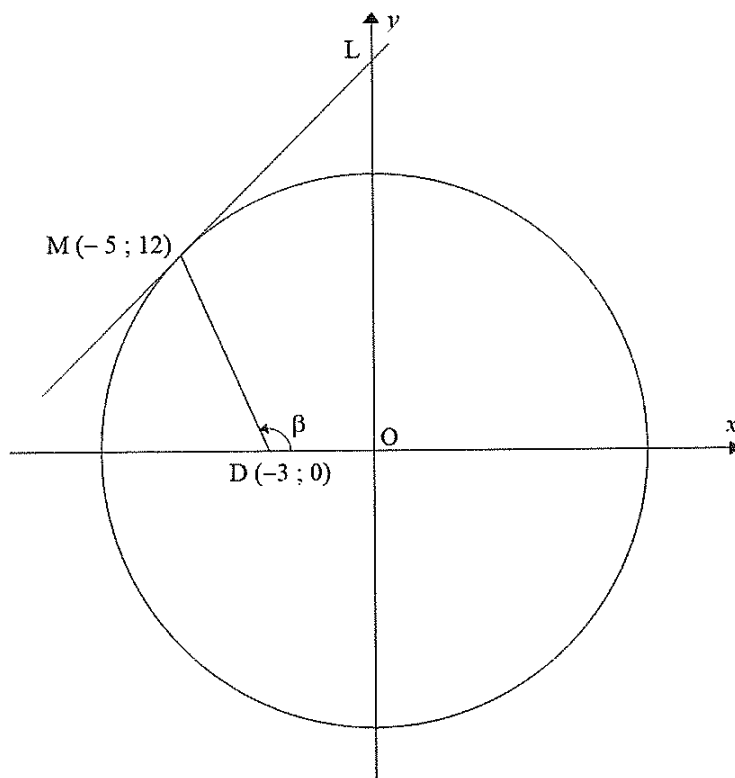

	<b>Solution/Oplissing</b>	<b>Marks Punte</b>
2.1.1		(2)
2.1.2		(4)

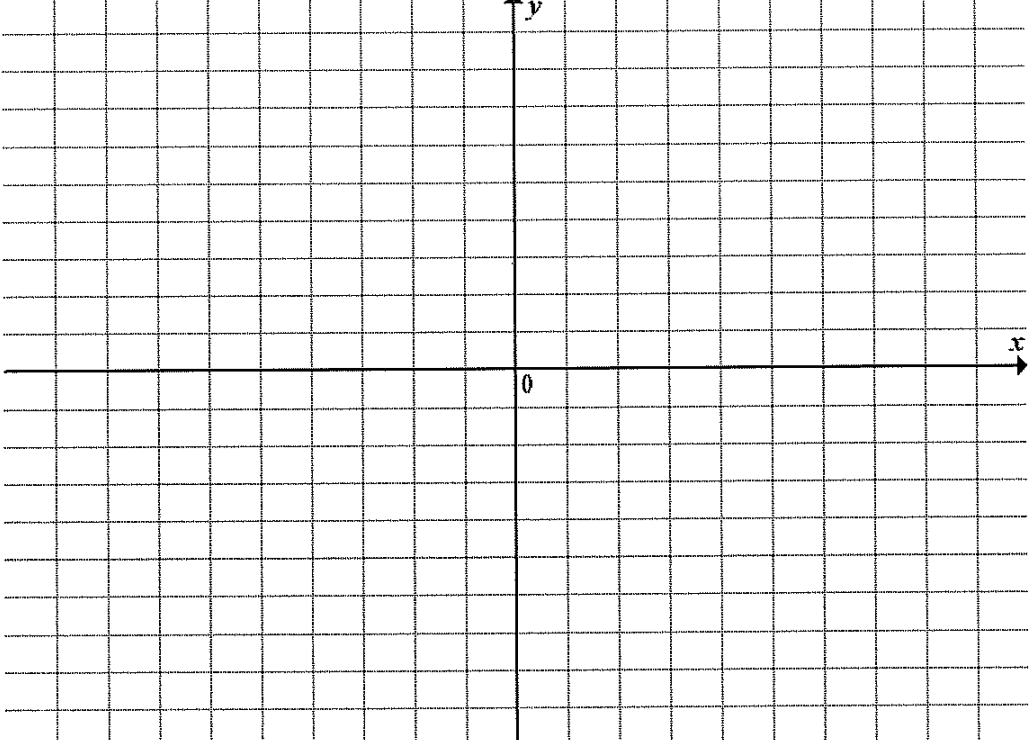

	<b>Solution/Oplissing</b>	<b>Marks Punte</b>
2.1.3		(2)
2.1.4		(4)
2.2		(3)
		<b>[15]</b>



**QUESTION/VRAAG 3**

	<b>Solution/Oplissing</b>	<b>Marks Punte</b>
3.1.1		(3)
3.1.2		(2)
3.2		(6)
3.3		(4)
		<b>[15]</b>

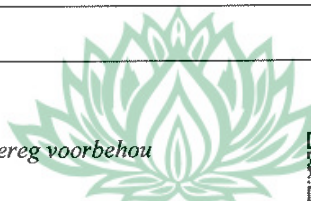



**QUESTION/VRAAG 4**

	<b>Solution/Oplissing</b>	<b>Marks Punte</b>
4.1.1		(1)
4.1.2		(5)
4.2		(1)
4.3		(3)
		<b>[10]</b>

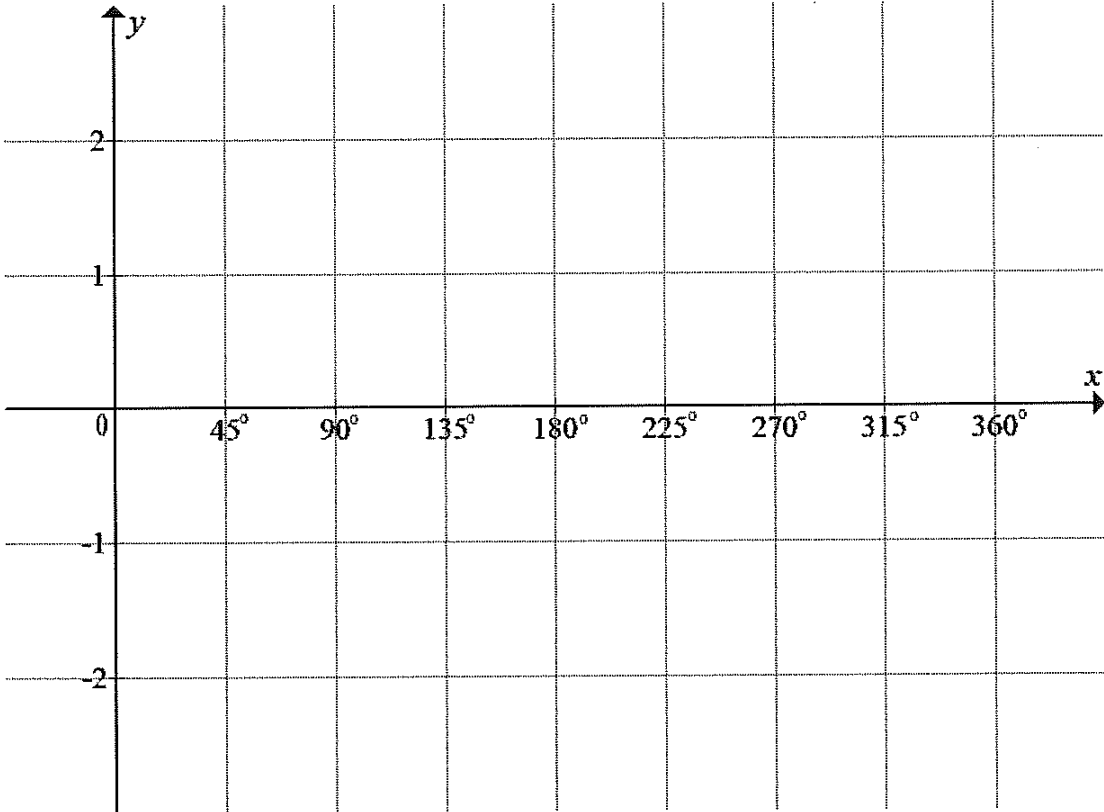

**QUESTION/VRAAG 5**

	Solution/Oplissing	Marks Punte
5.1		(7)
5.2	<hr/> <hr/> <hr/>	(1)
5.3	<hr/> <hr/> <hr/>	(1)
5.4	<hr/> <hr/> <hr/>	(3)
5.5	<hr/> <hr/> <hr/>	(2)
		<b>[14]</b>

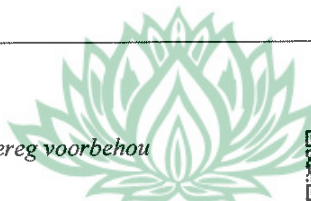

**QUESTION/VRAAG 6**

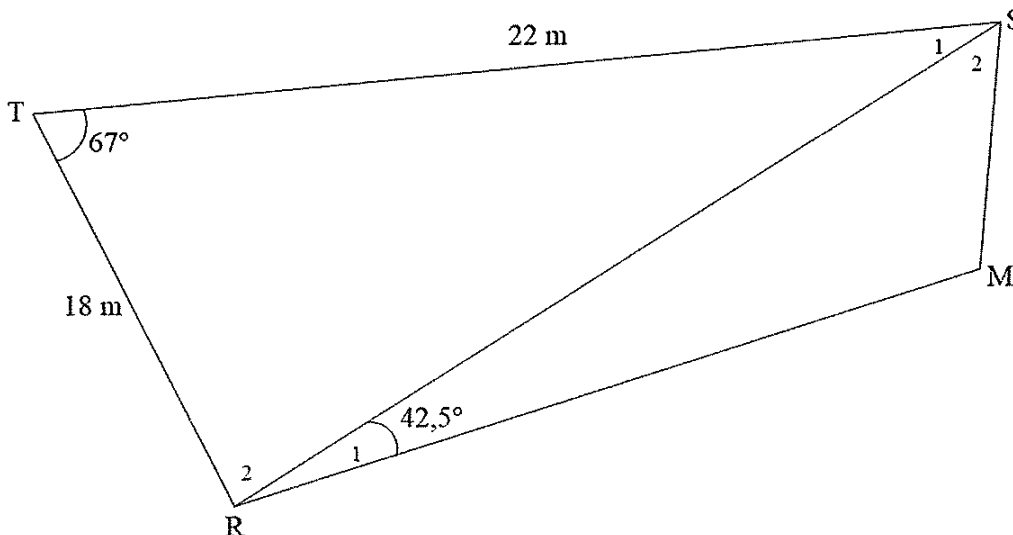

	<b>Solution/Oplissing</b>	<b>Marks Punte</b>
6.1.1		(3)
6.1.2		(1)
6.2.1		(1)



	<b>Solution/Oplissing</b>	<b>Marks Punte</b>
6.2.2		
6.3		(5)
		<b>[12]</b>



Give reasons for your statements in QUESTIONS 7, 8 and 9.

Gee redes vir jou bewerings in VRAAG 7, 8 en 9.

QUESTION/VRAAG 7

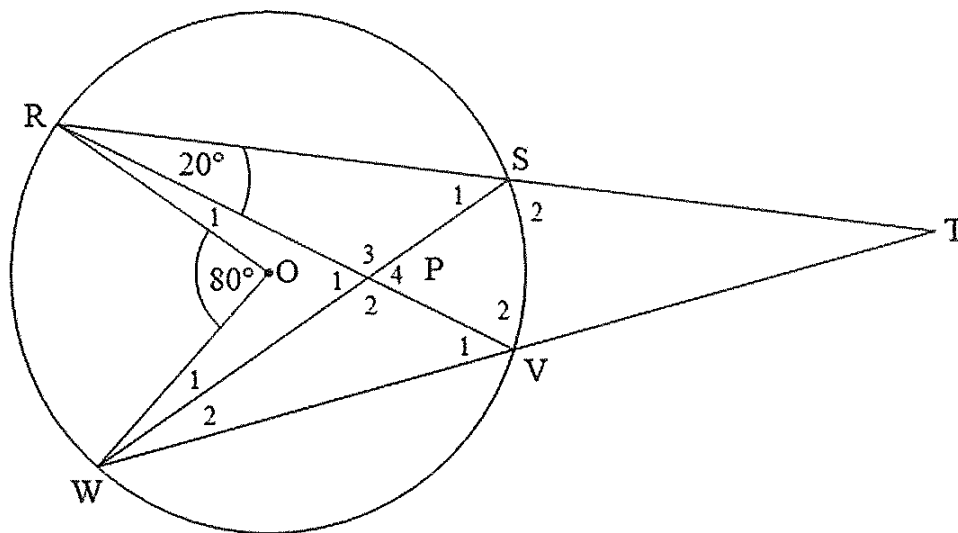

	Solution/Oplissing	Marks Punte
7.1.1		(2)
7.1.2		(2)
7.2		(3)
		[7]



**QUESTION/VRAAG 8**

8.1

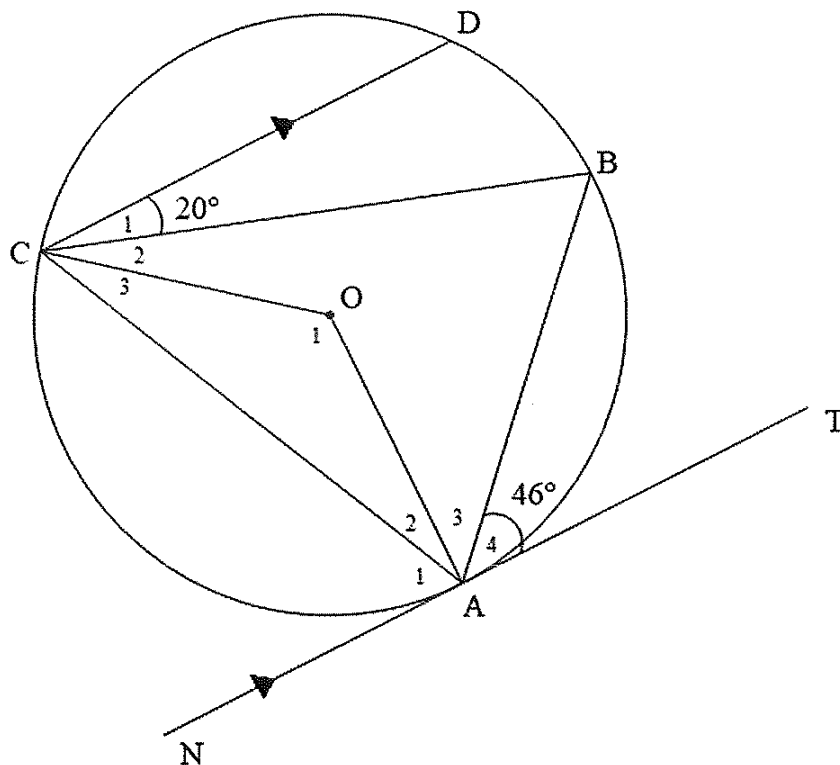

	<b>Solution/Oplissing</b>	<b>Marks Punte</b>
8.1.1		(2)
8.1.2		(3)
8.1.3		(2)

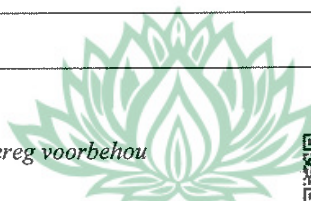

	Solution/Oplissing	Marks Punte
8.1.4		(3)

8.2

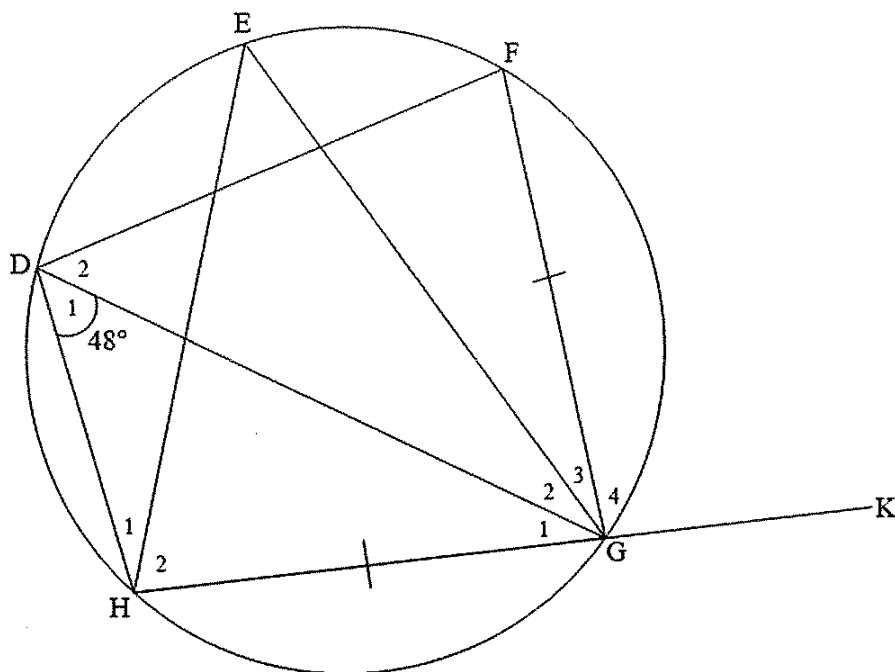

	Solution/Oplissing	Marks Punte
8.2.1		(2)
8.2.2		(2)

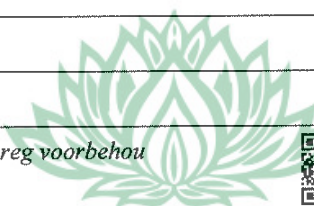

	<b>Solution/Oplissing</b>	<b>Marks Punte</b>
8.2.3		(2)
		<b>[16]</b>





**QUESTION/VRAAG 9**

9.1

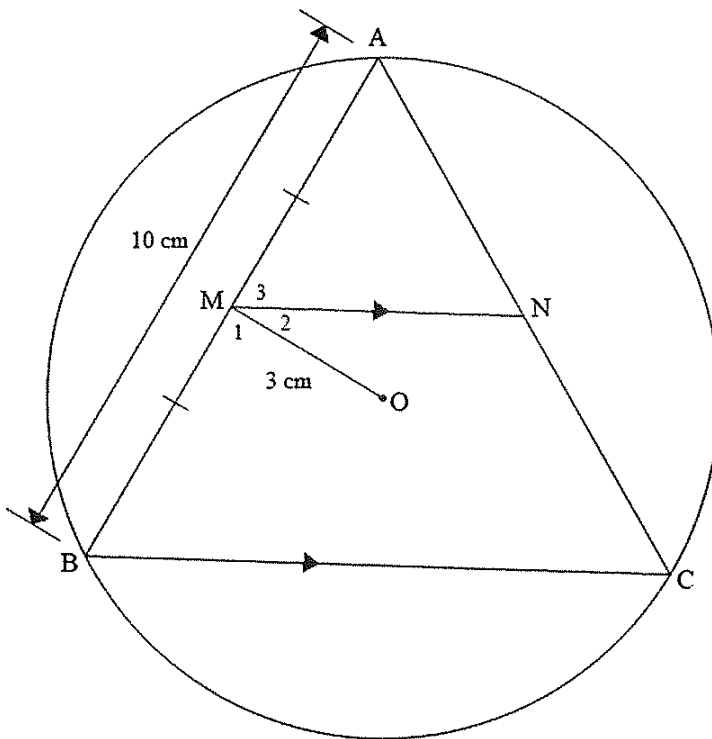

	<b>Solution/Oplissing</b>	<b>Marks Punte</b>
9.1.1(a)		(2)
9.1.1(b)		(3)
9.1.2		(2)

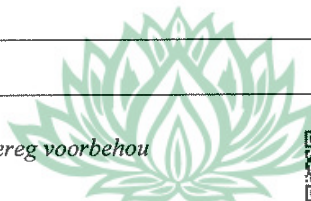

9.2

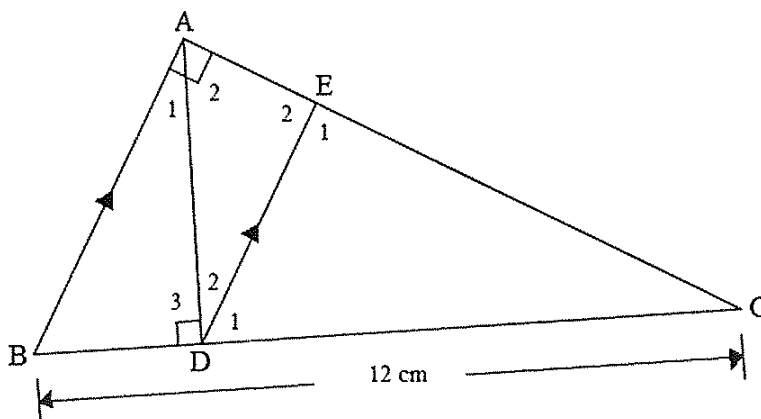

	Solution/Oplissing	Marks Punte
9.2.1		(3)
9.2.2		(1)
9.2.3(a)		(2)
9.2.3(b)		(2)
9.2.3(c)		(2)
		[17]

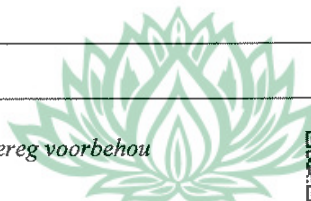

**QUESTION/VRAAG 10**

10.1

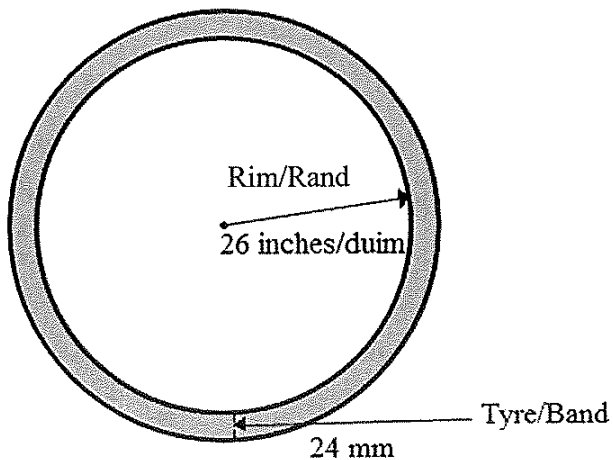

	<b>Solution/Oplissing</b>	<b>Marks Punte</b>
10.1.1		(1)
10.1.2		(2)
10.1.3		(4)

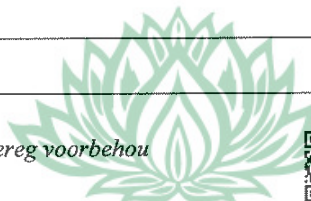

10.2

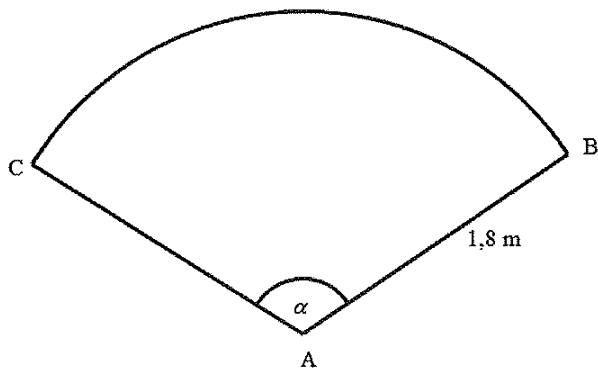

	Solution/Oplissing	Marks Punte
		(5)



10.3

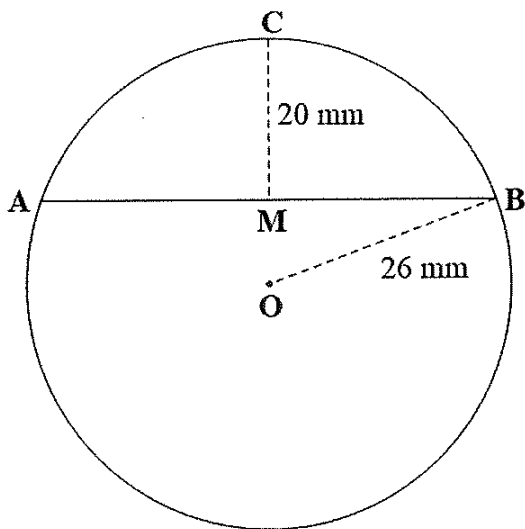

	Solution/Oplissing	Marks Punte
		(4)
		(4)
		<b>[16]</b>



**QUESTION/VRAAG 11**

11.1

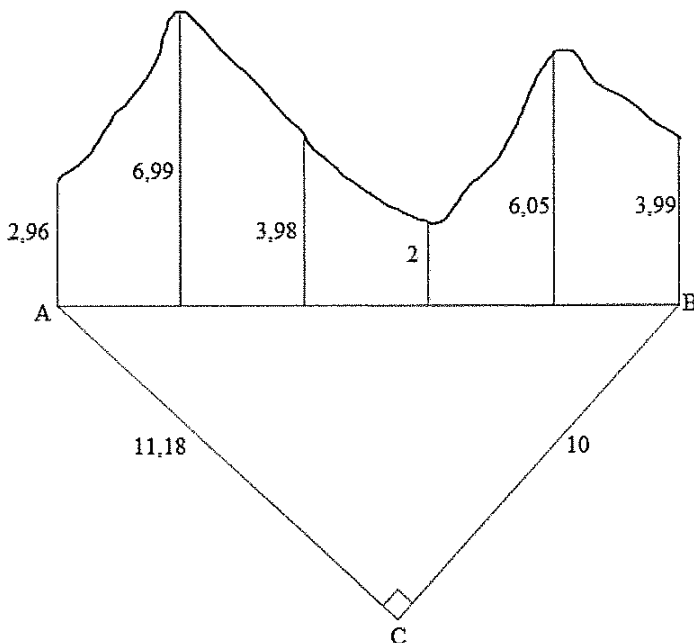

	<b>Solution/Oplissing</b>	<b>Marks Punte</b>
11.1.1		(2)
11.1.2		(1)
11.1.3		(3)

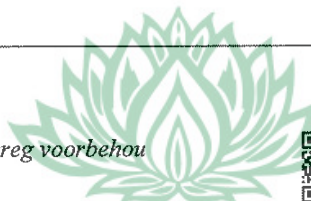

11.2

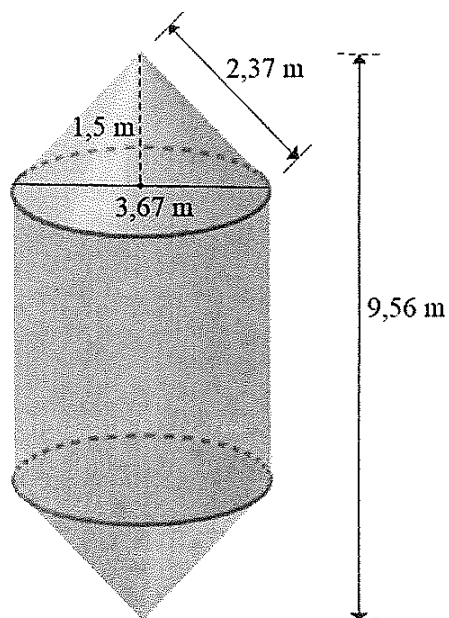

	Solution/Oplissing	Marks Punte
11.2.1(a)		(1)
11.2.1(b)		(1)
11.2.2		(3)



11.2.3		
	(6)	
	[17]	

**TOTAL/TOTAAL: 150**













