

# SA's Leading Past Year

## Exam Paper Portal



You have Downloaded, yet Another Great Resource to assist you with your Studies 😊

Thank You for Supporting SA Exam Papers

Your Leading Past Year Exam Paper Resource Portal

Visit us @ [www.saexampapers.co.za](http://www.saexampapers.co.za)



**SA EXAM  
PAPERS**  
SA EXAM  
PAPERS



**basic education**  
 Department:  
 Basic Education  
 REPUBLIC OF SOUTH AFRICA

Candidate Barcode Label/Stafieskodeplakker

*NSC Answer Book*  
*NSC-antwoordeboek*

National Senior Certificate/Nasionale Senior Sertifikaat (Grade 12/Graad 12) 2023

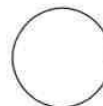

CENTRE NUMBER  
 SENTRUMNOMMER

--	--	--	--	--	--	--	--	--	--

EXAMINATION NUMBER  
 EKSAMENNOMMER

--	--	--	--	--	--	--	--	--	--	--	--

Sequence no on mark sheet  
 Volgnommer op puntetaal

DATE  
 DATUM

--	--	--	--	--	--	--	--	--	--

BOOK NUMBER BOEKNOMMER	OF VAN	BOOKS BOEKE
---------------------------	-----------	----------------

SUBJECT CODE  
 VAKKODE

--	--	--	--	--	--

PAPER NUMBER  
 VRAESTELNOMMER

2
---

SUBJECT NAME  
 VAKNAAM

**TECHNICAL MATHEMATICS/TEGNIËSE WISKUNDE**

MARKER/NASIENER			MODERATOR'S INITIALS IN RELEVANT BLOCK/ MODERATORPARAAF IN BETROKKE BLOKKIE						RE-MARK/RE-CHECK/ HERNASIEN/HERKONTROLEER		
Question Vraag	Marks Punte	Marker's Code & Initials	Marks Punte	SM	DCM	CM	IM	EM	Question Vraag	Marks Punte	Initials Paraaf
1									1		
2									2		
3									3		
4									4		
5									5		
6									6		
7									7		
8									8		
9									9		
10									10		
11									11		
12									12		
13									13		
14									14		
15									15		
16									16		



CONTROLLED AND CERTIFIED CORRECT  
 SURNAME AND INITIALS OF EA

--	--	--	--	--	--	--	--	--	--	--	--

PLEASE READ INSTRUCTIONS ON THE NEXT PAGE  
 LEES ASSEBLIEF INSTRUKSIES OP VOLGENDE BLADSY

**This answer book consists of 26 pages./Hierdie antwoordeboek bestaan uit 26 bladsye.**

PLEASE FOLLOW THESE INSTRUCTIONS CAREFULLY	VOLG ASSEBLIEF HIERDIE INSTRUKSIES NOUKEURIG
<p>1. Your examination number and centre number must be clearly written in the space provided and attach your examination number sticker in the space provided.</p> <p>2. Remember that your own name (or the name of your school) may not appear anywhere on or in this answer book.</p> <p>3. Answer ALL questions in the spaces provided.</p> <p>4. No pages may be torn from this answer book.</p> <p>5. Read the instructions printed on your timetable carefully as well as any other instructions which may be given in each examination paper.</p> <p>6. Candidates may not retain an answer book or remove it from the examination room. Answer books must be returned to the Invigilator at the end of the examination session.</p> <p>7. Answers must be written in black/blue ink as distinctly as possible. Do NOT write in the margins.</p> <p>8. Indicate the questions you have answered by drawing a circle around the relevant numbers on the front cover of the answer book where marks are to be recorded.</p> <p>9. Draw a neat line through any work/rough work that must not be marked.</p> <p>10. In the event that you use the additional space provided:  10.1 Write down the question number question  10.2 Leave a line and rule off after your answer.</p>	<p>1. Skryf jou eksamenommer en sentrumnummer duidelik in die ruimtes verskaf en plak jou eksamenommeretiket in die ruimte verskaf.</p> <p>2. Onthou dat jou eie naam (of die naam van jou skool) nie op of in hierdie antwoordeboek mag voorkom nie.</p> <p>3. Beantwoord ALLE vrae in die ruimtes wat verskaf is.</p> <p>4. Geen bladsye mag uit hierdie antwoordeboek geskeur word nie.</p> <p>5. Lees die instruksies wat op jou eksamenrooster gedruk is sorgvuldig deur, asook enige ander instruksies wat in elke eksamenvraestel gegee word.</p> <p>6. Geen antwoordeboek mag deur die kandidaat behou of uit die eksamenlokaal verwyder word nie. Antwoordeboeke moet aan die einde van die eksamensessie aan die toesighouer terugbesorg word.</p> <p>7. Skryf die antwoorde so duidelik moontlik met swart/blou ink. MOENIE in die kantlyne skryf NIE.</p> <p>8. Dui die vrae wat jy beantwoord het op die voorblad van die antwoordeboek aan, waar die punte aangebring word, deur 'n kringetjie om die nommers van die vrae wat jy beantwoord het, te trek.</p> <p>9. Trek 'n netjiese lyn deur enige werk/rofwerk wat nie nagesien moet word nie.</p> <p>10. In geval jy die bykomende ruimte wat verskaf is, gebruik:  10.1 Skryf die vraagnommer neer  10.2 Laat 'n lyn oop en trek 'n lyn na jou antwoord.</p>



**QUESTION/VRAAG 1**

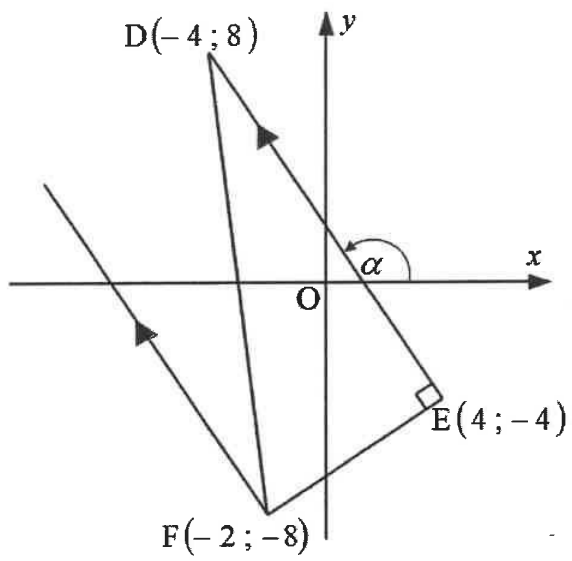

	<b>Solution/Oplissing</b>	<b>Marks Punte</b>
1.1		(2)
1.2		(3)



1.3		(4)
1.4		(5)
	(5)	
	[14]	



**QUESTION/VRAAG 2**

2.1

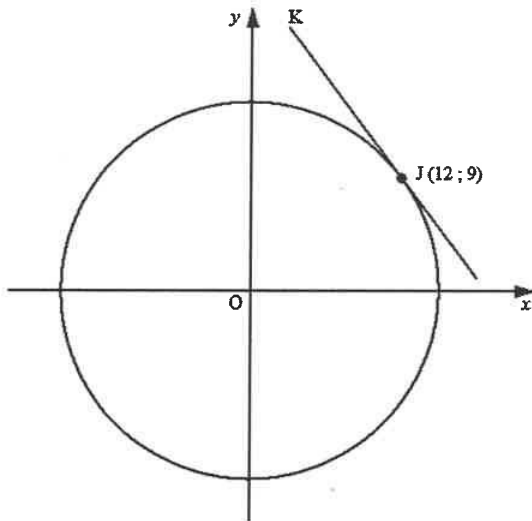

	<b>Solution/Oplissing</b>	<b>Marks Punte</b>
2.1.1		(2)
2.1.2		(1)
2.1.3		(4)

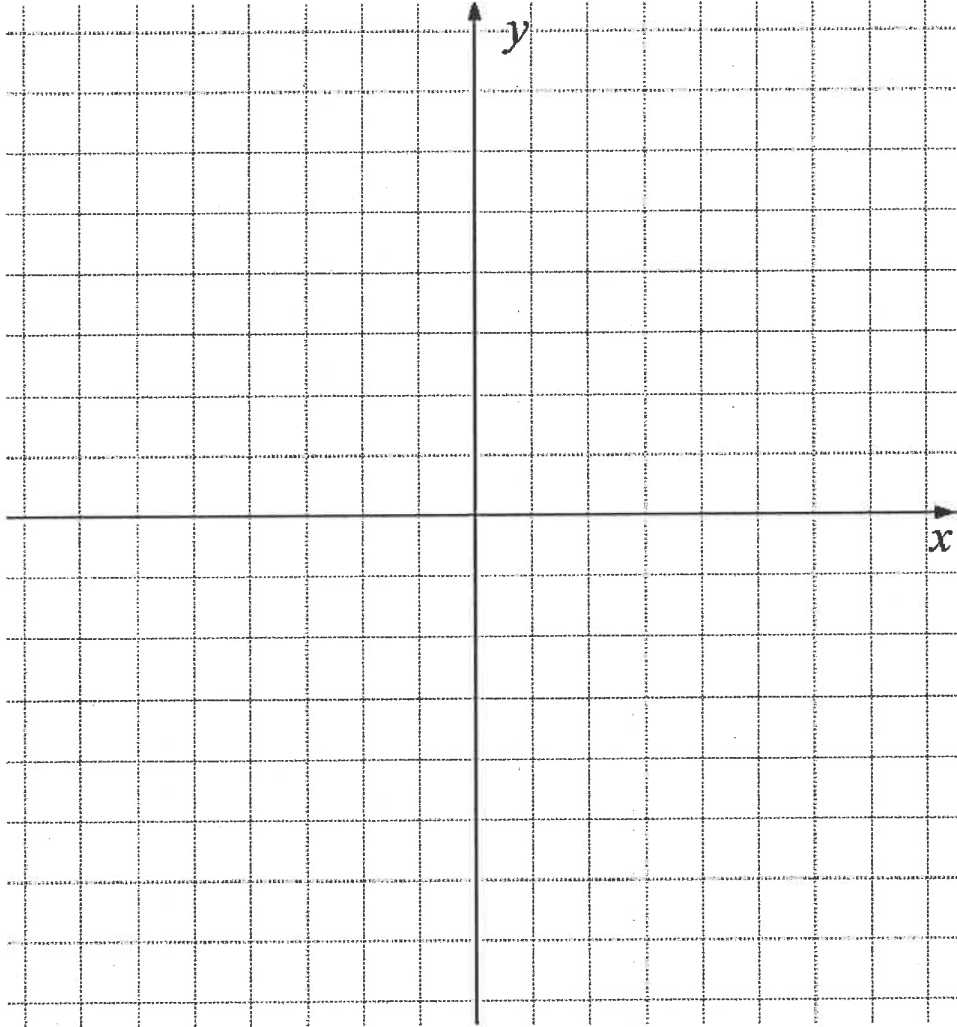

	Solution/Oplissing	Marks Punte
2.2.1		(1)
2.2.2		(2)
		<b>[10]</b>



**QUESTION/VRAAG 3**

	<b>Solution/Oplissing</b>	<b>Marks Punte</b>
3.1.1		(2)
3.1.2		(2)
3.2.1		(1)
3.2.2		(5)





3.3		
		(4)
		<b>[14]</b>

**QUESTION/VRAAG 4**

	<b>Solution/Oplissing</b>	<b>Marks Punte</b>
4.1.1		(1)
4.1.2		(1)
4.1.3		(1)
4.2		(7)

	<b>Solution/Oplissing</b>	<b>Marks Punte</b>
4.3.1		
		(1)
4.3.2		
		(4)
		<b>[15]</b>



**QUESTION/VRAAG 5**

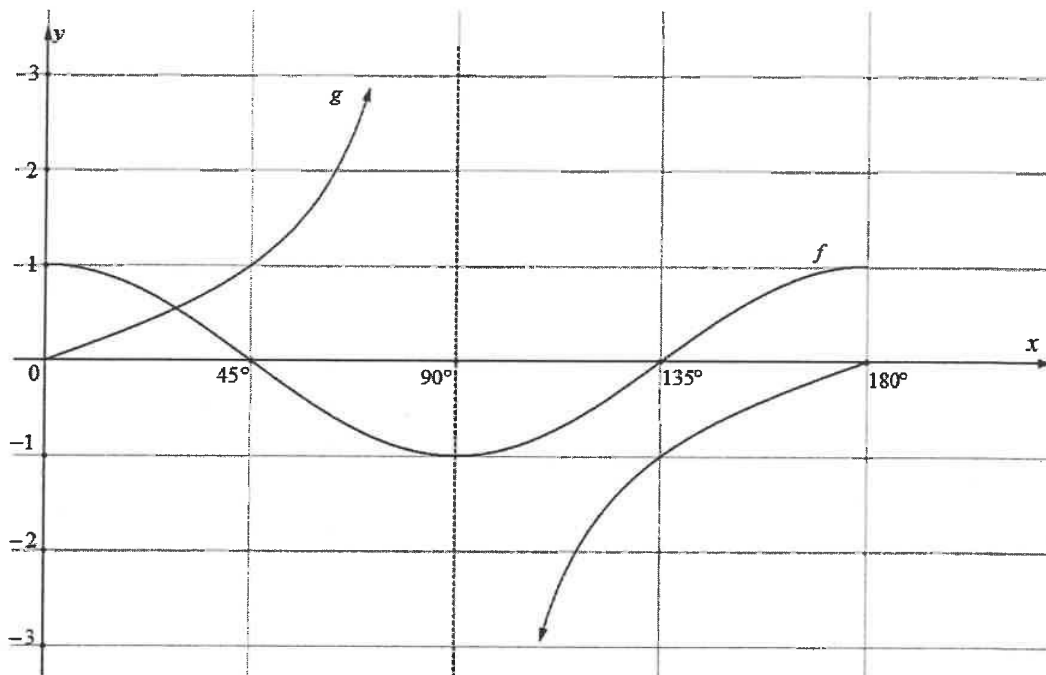

	<b>Solution/Oplissing</b>	<b>Marks Punte</b>
5.1.1		(1)
5.1.2		(1)
5.1.3		(2)
5.1.4		(1)
5.1.5		(2)
5.2		(2)
5.3		(2)
		<b>[11]</b>



**QUESTION/VRAAG 6**

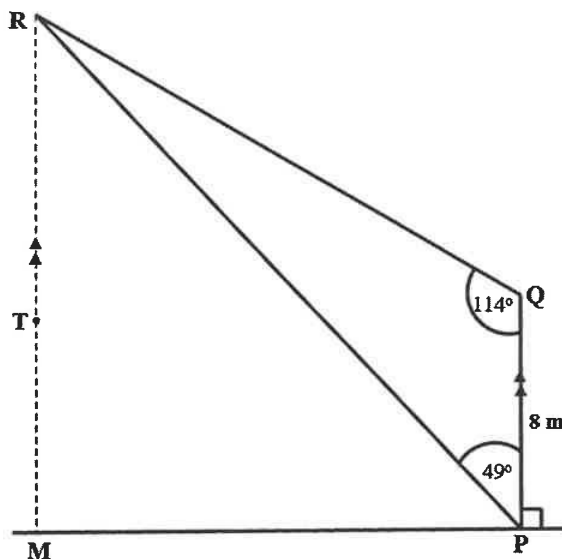

	<b>Solution/Oplissing</b>	<b>Marks Punte</b>
6.1		(4)
6.2		(1)

6.3		(1)
6.4		(3)
	(3)	
	[9]	



**Give reasons for your statements in QUESTIONS 7, 8 and 9.**  
*Gee redes vir jou bewerings in VRAAG 7, 8 en 9.*

**QUESTION/VRAAG 7**

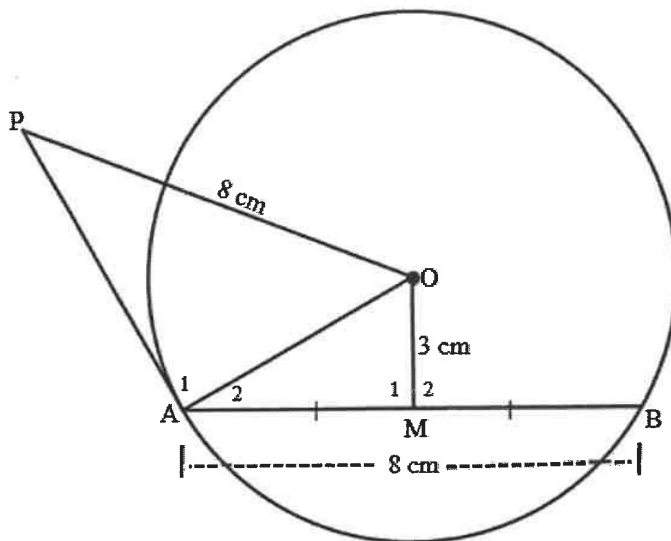

	<b>Solution/Oplissing</b>	<b>Marks Punte</b>
7.1		(2)
7.2		(1)
7.3		(3)
	(3)	
	[6]	



**QUESTION/VRAAG 8**

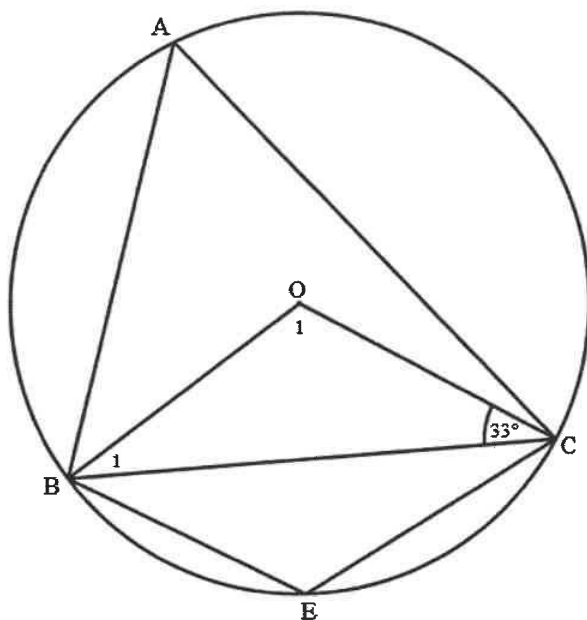

	<b>Solution/Oplissing</b>	<b>-Marks Punte</b>
8.1.1		(2)
8.1.2		(2)
8.1.3		(4)





8.2

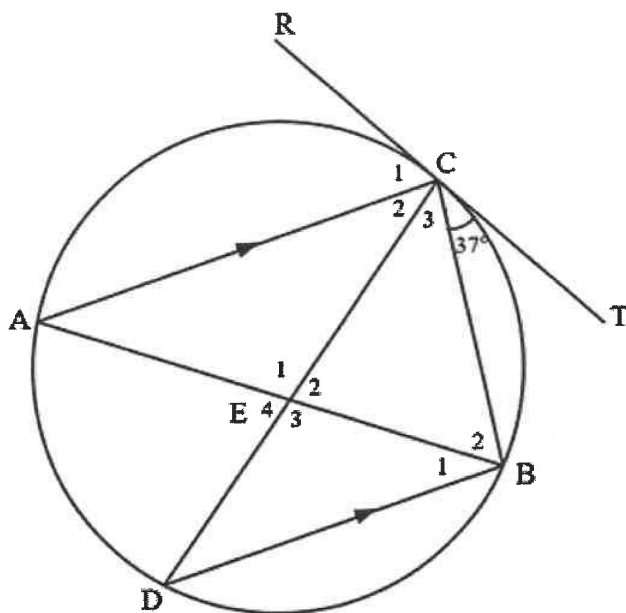

	Solution/Oplissing	Marks Punte
8.2.1		(6)
8.2.2		(2)
8.2.3		(2)



8.3

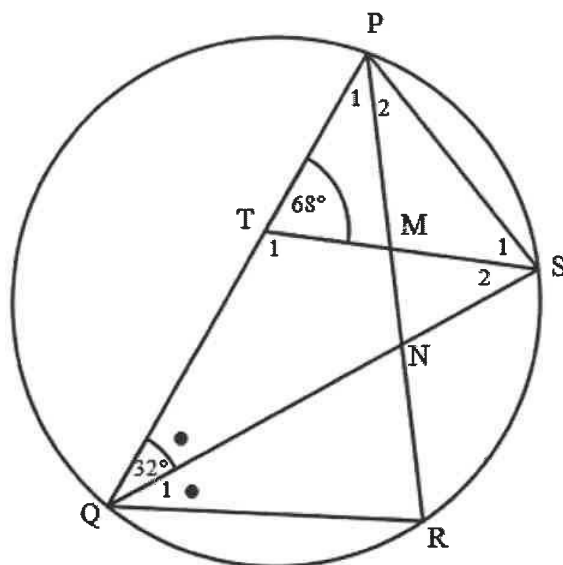

	Solution/Oplissing	Marks Punte
8.3.1 (a)		(1)
8.3.1 (b)		(2)
8.3.2		(5)
	<b>[26]</b>	

**QUESTION/VRAAG 9**

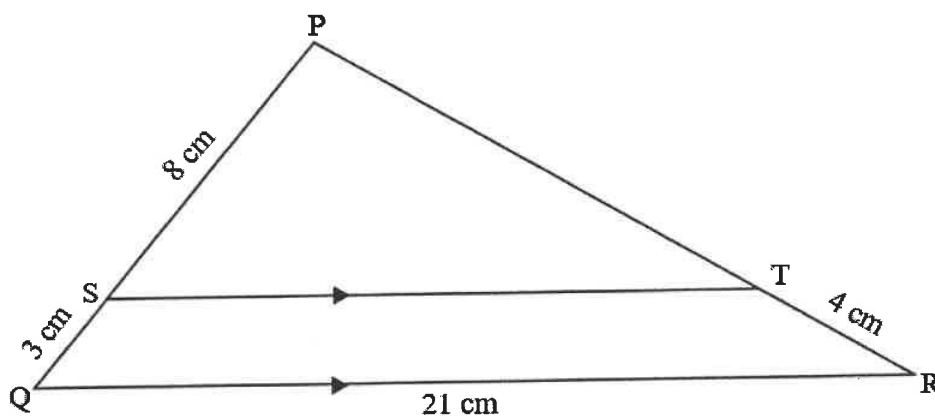

	Solution/Oplissing	Marks Punte
9.1		(1)
9.2		(2)
9.3		(2)
9.4		(2)
		[7]



**QUESTION/VRAAG 10**

10.1

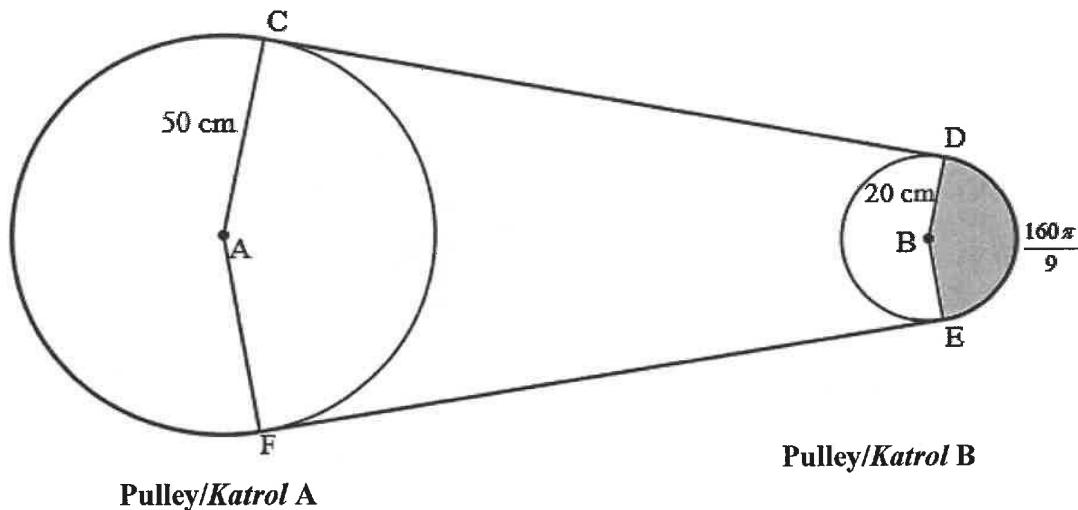

	<b>Solution/Oplissing</b>	<b>Marks Punte</b>
10.1.1		(1)
10.1.2		(1)
10.1.3		(3)



	<b>Solution/Oplissing</b>	<b>Marks Punte</b>
10.1.4 (a)		
10.1.4 (b)		
		(3)
		(4)

	Solution/Oplissing	Marks Punte
10.1.5		(3)

10.2

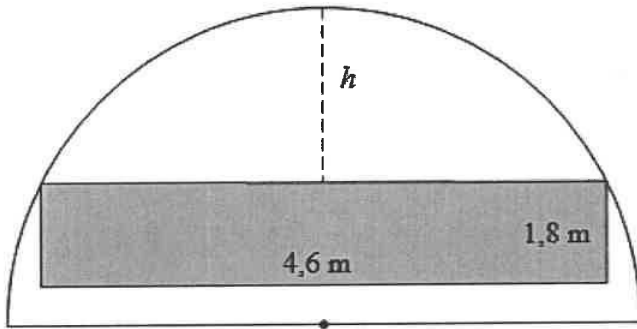

10.2.1		(1)
10.2.2		(4)
		[20]



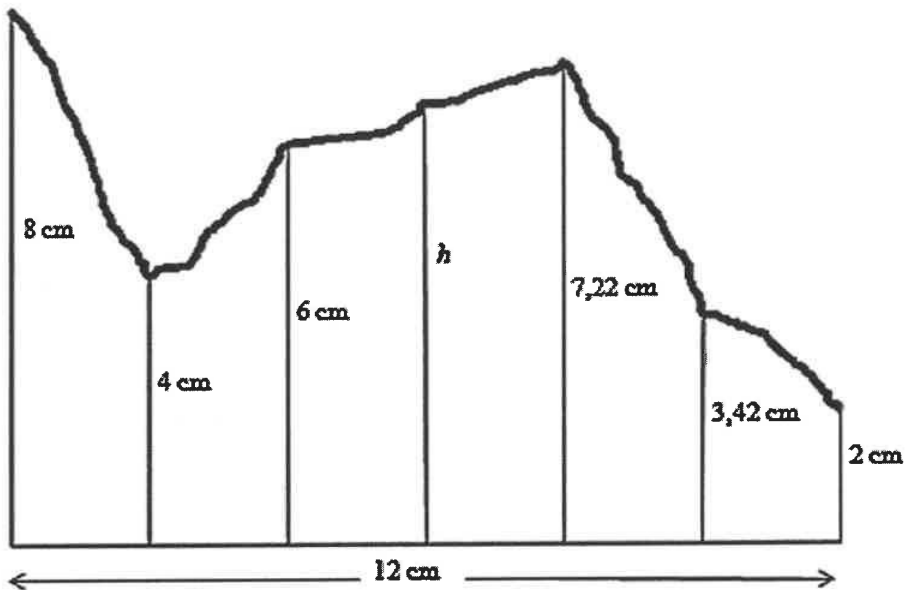

**QUESTION/VRAAG 11**

11.1



	<b>Solution/Oplissing</b>	<b>Marks Punte</b>
11.1.1		(1)
11.1.2		(2)
11.1.3		(3)

11.2

<p>Soccer ball A with radius <math>r = 11</math> cm <i>Sokkerbal A met radius <math>r = 11</math> cm</i></p>  <p>Picture/Prent A</p>	<p>Soccer ball B with radius <math>r = x</math> cm <i>Sokkerbal B met radius <math>r = x</math> cm</i></p>  <p>Picture/Prent B</p>
---	--

<b>Solution/Oplissing</b>	<b>Marks Punte</b>
	<b>(5)</b>





11.3

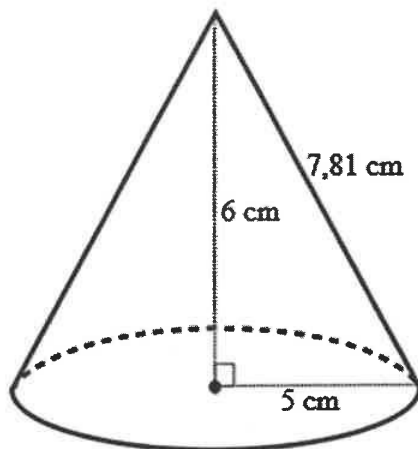

	<b>Solution/Oplissing</b>	<b>Marks Punte</b>
11.3.1		(2)
11.3.2		(5)
		[18]





