

SA's Leading Past Year

Exam Paper Portal



You have Downloaded, yet Another Great Resource to assist you with your Studies 😊

Thank You for Supporting SA Exam Papers

Your Leading Past Year Exam Paper Resource Portal

Visit us @ www.saexampapers.co.za





basic education

Department:
Basic Education
REPUBLIC OF SOUTH AFRICA

SENIOR CERTIFICATE EXAMINATIONS/ NATIONAL SENIOR CERTIFICATE EXAMINATIONS

LIFE SCIENCES P1

2023

MARKS: 150

TIME: 2½ hours

This question paper consists of 15 pages.

INSTRUCTIONS AND INFORMATION

Read the following instructions carefully before answering the questions.

1. Answer ALL the questions.
2. Write ALL the answers in the ANSWER BOOK.
3. Start the answers to EACH question at the top of a NEW page.
4. Number the answers correctly according to the numbering system used in this question paper.
5. Present your answers according to the instructions of each question.
6. Do ALL drawings in pencil and label them in blue or black ink.
7. Draw diagrams, tables or flow charts only when asked to do so.
8. The diagrams in this question paper are NOT necessarily drawn to scale.
9. Do NOT use graph paper.
10. You must use a non-programmable calculator, protractor and a compass, where necessary.
11. Write neatly and legibly.

SECTION A**QUESTION 1**

1.1 Various options are provided as possible answers to the following questions. Choose the answer and write only the letter (A–D) next to the question numbers (1.1.1 to 1.1.10) in the ANSWER BOOK, e.g. 1.1.11 D.

1.1.1 Diabetes mellitus is caused by an ...

- A oversecretion of glucagon.
- B undersecretion of glucagon.
- C oversecretion of insulin.
- D undersecretion of insulin.

1.1.2 Receptors that are stimulated by the low water levels in the blood are located in the ...

- A renal tubules.
- B hypothalamus.
- C pituitary gland.
- D carotid artery.

1.1.3 The myelin sheath on a nerve cell ...

- A provides electrical insulation.
- B transports impulses towards the cell body.
- C receives impulses from the axon.
- D converts stimuli into impulses.

1.1.4 The structure where sperms are temporarily stored is the ...

- A testis.
- B epididymis.
- C vas deferens.
- D penis.

1.1.5 Which ONE of the following is a function of the amniotic fluid?

- A Provides nutrition to the foetus
- B Protects the foetus against mechanical injury
- C Supplies oxygen to the foetus
- D Removes the metabolic waste from the foetus

QUESTIONS 1.1.6 AND 1.1.7 ARE BASED ON THE DIAGRAM OF THE BRAIN BELOW.

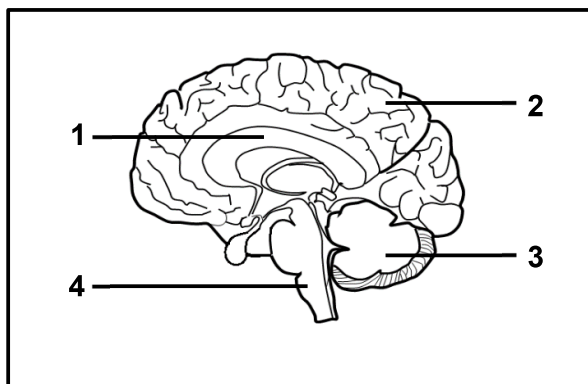

- 1.1.6 Which ONE of the following represents the corpus callosum?
- A 1
 - B 2
 - C 3
 - D 4
- 1.1.7 Which ONE of the following is the function of part 3?
- A Controls voluntary movements
 - B Controls involuntary actions
 - C Coordinates voluntary movements
 - D Controls all sensations
- 1.1.8 The placenta is formed by the ...
- A amniotic fluid and amnion.
 - B chorionic villi and endometrium.
 - C amnion and endometrium.
 - D amniotic fluid and chorionic villi.
- 1.1.9 An oversecretion of the hormone produced by the thyroid gland may result in a person ...
- A gaining weight, because of an increased metabolic rate.
 - B gaining weight, because of a decreased metabolic rate.
 - C losing weight, because of an increased metabolic rate.
 - D losing weight, because of a decreased metabolic rate.

- 1.1.10 The table below shows the average testosterone levels of males of different age groups.

Group	Age (years)	Average testosterone level (n/M)
I	0–10	less than 5
II	11–15	15
III	16–20	19

Which ONE of the following is an explanation for the difference in testosterone levels between the age groups?

Testosterone levels are higher in ...

- A Group I than Group III due to the start of puberty.
- B Group II than Group I due to the start of puberty.
- C Group III than Group I because it is needed to inhibit the growth of long bones.
- D Group I than Group II because it is needed to inhibit the growth of long bones.

(10 x 2) (20)

1.2 Give the correct **biological term** for each of the following descriptions. Write only the term next to the question numbers (1.2.1 to 1.2.8) in the ANSWER BOOK.

- 1.2.1 The process of maintaining a constant internal environment in the human body
- 1.2.2 The organelles found in large quantities in the neck region of a sperm cell
- 1.2.3 The disease characterised by the degeneration of brain tissue, leading to memory loss
- 1.2.4 The layer in the eye that is richly supplied with blood vessels
- 1.2.5 The type of development in birds in which the young is born fully developed and able to move and feed itself
- 1.2.6 Groups of cells in the pancreas that secrete insulin and glucagon
- 1.2.7 The structure in the sperm that contains enzymes to dissolve the outer layer of the ovum
- 1.2.8 A blood vessel that transports carbon dioxide from the foetus to the placenta (8 x 1) **(8)**

1.3 Indicate whether each of the descriptions in COLUMN I apply to **A ONLY**, **B ONLY**, **BOTH A AND B** or **NONE** of the items in COLUMN II. Write **A only**, **B only**, **both A and B** or **none** next to the question numbers (1.3.1 to 1.3.3) in the ANSWER BOOK.

COLUMN I		COLUMN II	
1.3.1	An extra-embryonic membrane found in the amniotic egg	A:	Chorion
		B:	Allantois
1.3.2	A structure in the ear that absorbs excess pressure waves from the cochlea	A:	Pinna
		B:	Auditory canal
1.3.3	A structure that transports semen out of the body	A:	Scrotum
		B:	Urethra

(3 x 2) **(6)**

1.4 The flow diagram below represents the components of the nervous system.

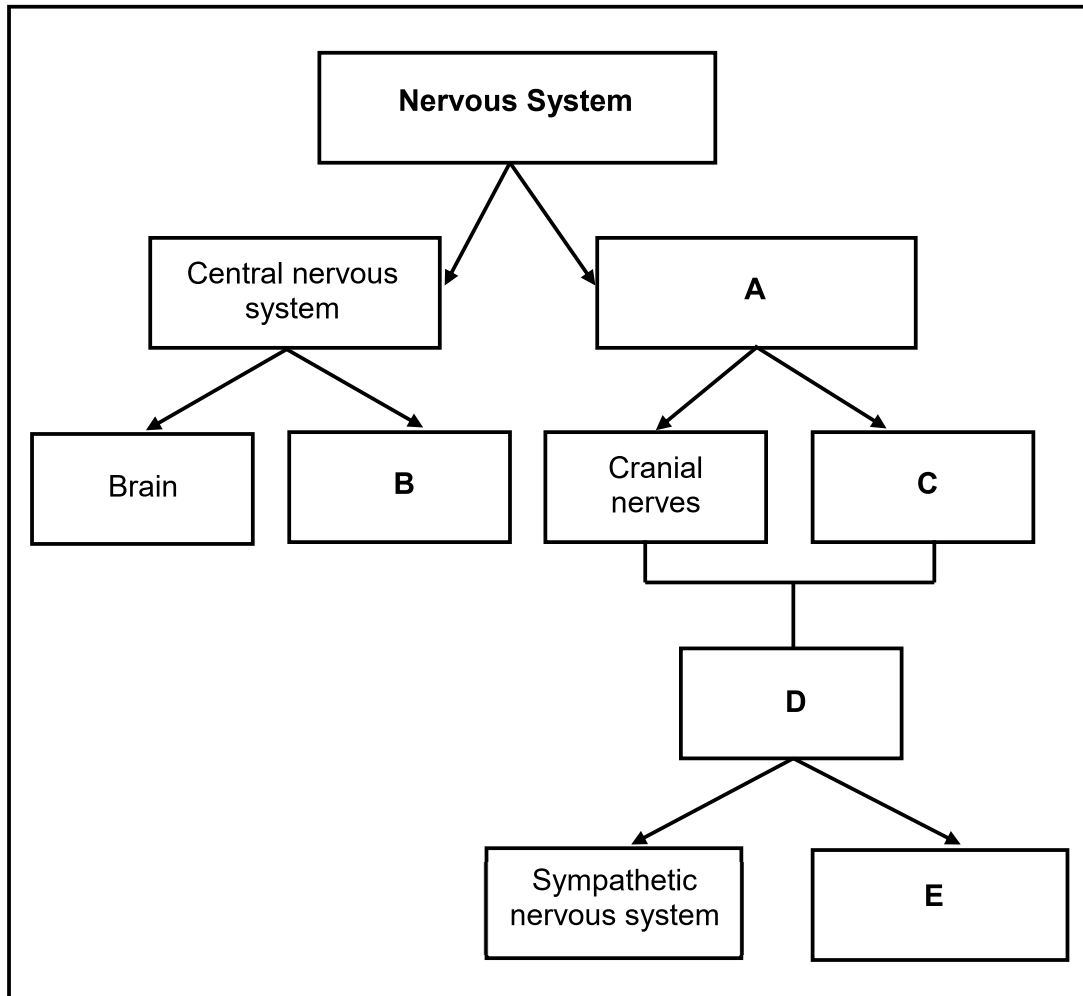

- 1.4.1 Identify the component of the nervous system represented by:
- (a) **A** (1)
- (b) **D** (1)
- 1.4.2 Name the type of nerves found at **C**. (1)
- 1.4.3 Give the LETTER and NAME of the component that slows down the heart rate when an emergency situation has passed. (2)
- 1.4.4 Name the nerve cells that make up nervous tissue. (1)
- 1.4.5 State TWO ways in which the brain is protected. (2)
- (8)**

1.5 The diagrams below show parts of the middle and inner ear.

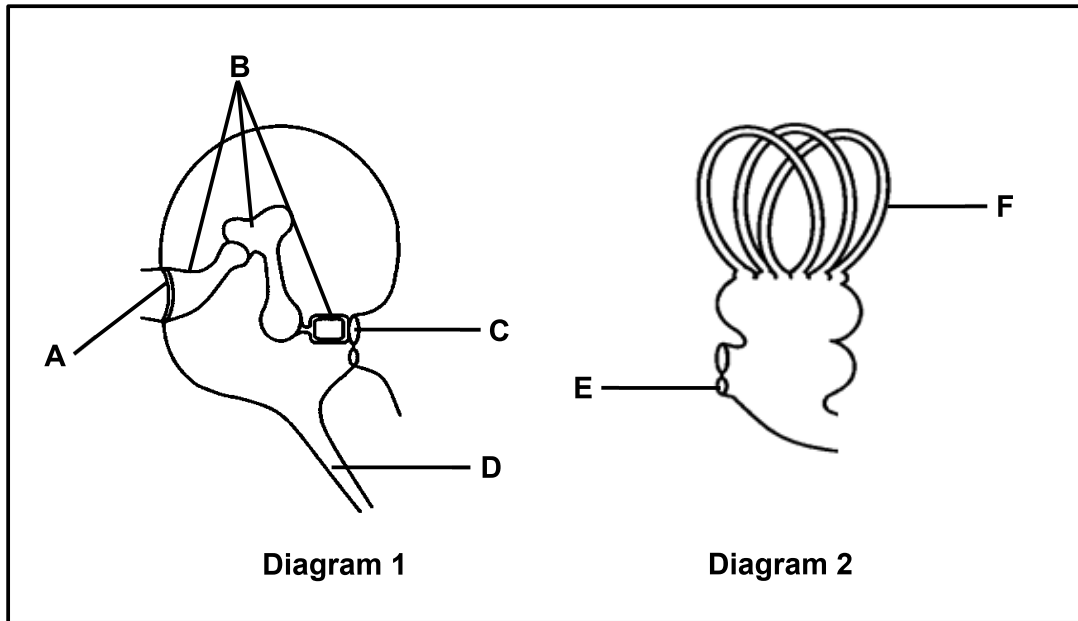

- 1.5.1 Identify part **F**. (1)
- 1.5.2 Give the collective term for bones **B**. (1)
- 1.5.3 Give the LETTER and NAME of the structure that:
- (a) Equalises pressure between the outer and middle ear (2)
- (b) Creates pressure waves in the inner ear (2)
- 1.5.4 Name the receptors that are stimulated by a change in the:
- (a) Position of the head (1)
- (b) Direction and speed of movement of the head (1)
- (8)**

TOTAL SECTION A: 50

SECTION B**QUESTION 2**

2.1 The diagram below represents the female reproductive system.

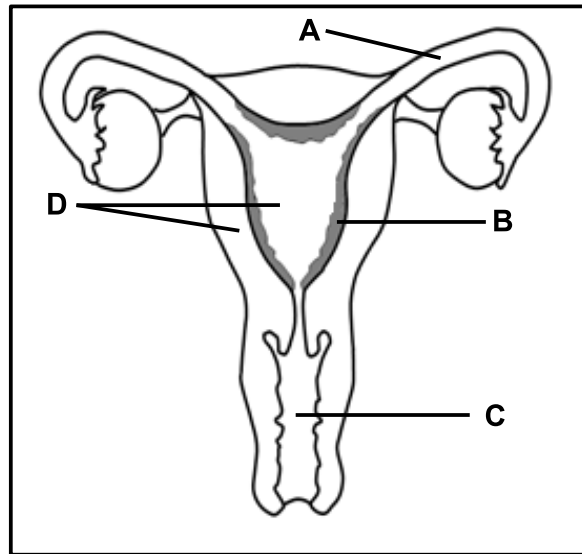

- 2.1.1 Identify part **B**. (1)
- 2.1.2 Name the process that takes place in part **A** that leads to zygote formation. (1)
- 2.1.3 Describe the process named in QUESTION 2.1.2. (1)
- 2.1.4 Describe the development of the zygote until implantation occurs. (4)
- 2.1.5 Explain TWO ways in which part **D** is structurally suited for gestation. (4)
- 2.1.6 Describe how the secretion of the prostate gland provides protection for the sperm from the conditions in part **C**. (2)
- (13)**

2.2 Read the extract below.

PLASTIC LINKED TO FEMALE INFERTILITY

Several studies indicate that bisphenol A (BPA), a chemical used in the production of many household plastic products, may be linked to female infertility (inability to get pregnant naturally and to deliver a healthy baby). BPA can be ingested or absorbed through the skin when using plastic products.

BPA seems to interfere with the normal secretion of FSH by the pituitary gland and is linked to abnormal menstrual cycles and reduced implantation rates. These studies also show a link between high BPA levels and a decrease in the development and maturation of ovarian follicles.

- 2.2.1 State ONE function of FSH. (1)
- 2.2.2 Name ONE other hormone in females that is secreted by the pituitary gland during the menstrual cycle. (1)
- 2.2.3 Explain how an undersecretion of the hormone in QUESTION 2.2.2 may lead to infertility. (2)
- 2.2.4 Explain why a decrease in the maturation of ovarian follicles may lead to reduced implantation rates. (5)
(9)
- 2.3 Describe the process of *spermatogenesis*. (4)
- 2.4 Frogs can survive in water and on land. Most frogs, however, need water for reproduction. During the breeding season, male and female frogs release millions of gametes into the water.
- 2.4.1 Name the type of fertilisation described above. (1)
- 2.4.2 Explain why millions of gametes are released. (3)
- 2.4.3 State why the reproduction in frogs is an example of ovipary. (1)
(5)

- 2.5 The diagram below shows parts of the skin that are involved in thermoregulation.

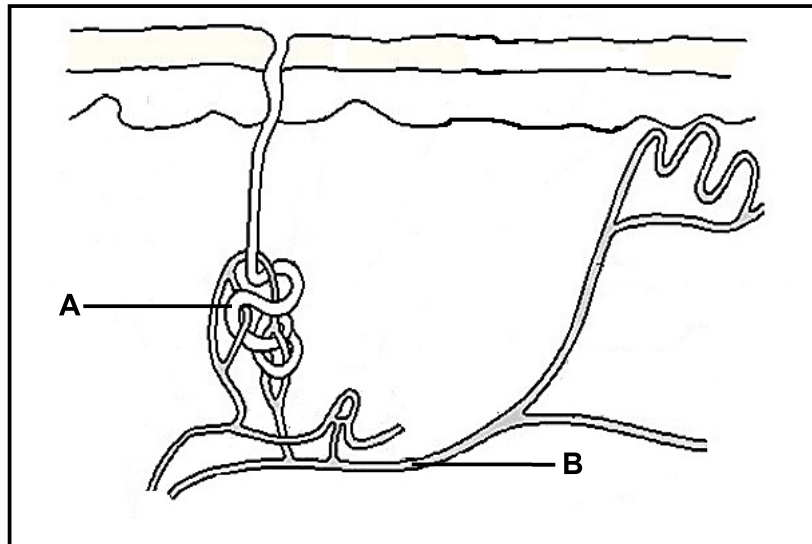

- 2.5.1 Give TWO reasons why part **A** is classified as an exocrine gland. (2)
- 2.5.2 Describe the role of skin receptors in thermoregulation. (2)
- 2.5.3 Explain why structure **B** dilates on a hot day. (2)
- (6)**

- 2.6 Workers in some factories are constantly exposed to loud noise for long periods. This can destroy the hair cells in the organ of Corti and damage the auditory nerve, resulting in hearing loss.

A survey was conducted in a developing country from 2014 to 2018, to establish the number of factory workers who suffered from hearing loss.

The results are shown in the table below.

Year	Number of factory workers with hearing loss
2014	85 000
2015	100 000
2016	115 000
2017	120 000
2018	130 000

- 2.6.1 Name the structure in the ear where the organ of Corti is located. (1)
- 2.6.2 Calculate the percentage increase in the number of factory workers with hearing loss between 2014 and 2018. Show ALL workings. (3)
- 2.6.3 Suggest ONE reason for the increase in the number of factory workers with hearing loss caused by exposure to loud noise in this country. (1)
- 2.6.4 Explain why damage to the auditory nerve may result in hearing loss. (2)
- 2.6.5 Draw a bar graph to represent the data in the table. (6)
- (13)**
[50]

QUESTION 3

- 3.1 The graph below shows the concentration of abscisic acid in a cherry tree during different seasons of the year.

This tree species loses all its leaves in autumn and goes into a state of dormancy during the winter months.

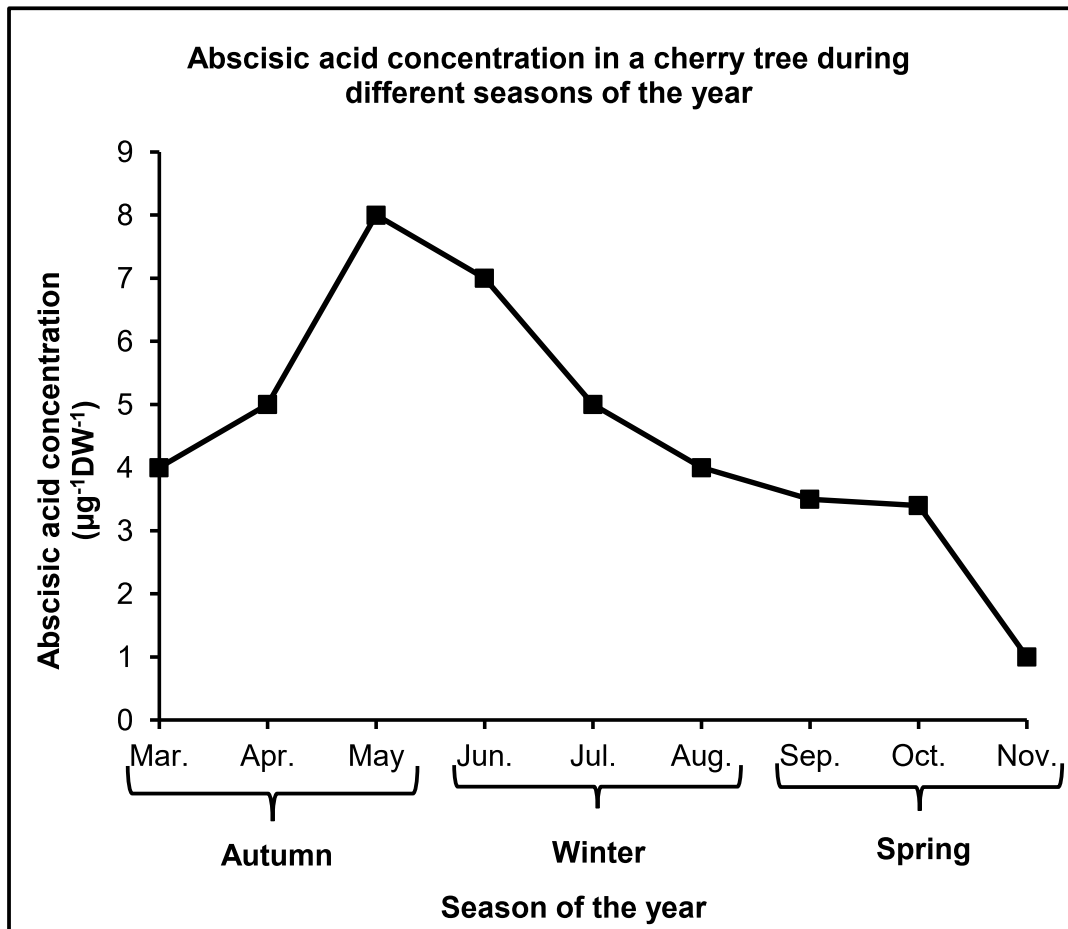

- 3.1.1 During which month was the abscisic acid concentration the lowest? (1)
- 3.1.2 Explain the trend of the graph from March to May. (3)
- 3.1.3 Suggest ONE reason for the dormancy in cherry trees during the winter months. (2)
- (6)**

3.2 Geotropism refers to the movement of a part of a plant in response to gravity. This tropism is controlled by auxins.

3.2.1 Describe the role of auxins in roots. (3)

3.2.2 When a plant is placed horizontally, with light coming from all directions, the auxins will accumulate on the lower side of both the stem and the roots.

Explain the difference in the response of the stem and the roots after a few days. (4)

(7)

3.3 Hyperaldosteronism is a disorder caused by the oversecretion of aldosterone and has been linked to high blood pressure in humans.

Scientists investigated the influence of increased aldosterone levels on blood pressure.

The procedure was done as follows:

- 1 688 healthy volunteers, aged 55, participated in the investigation.
- The participants' blood pressure was measured and recorded before the start of the investigation.
- The participants were injected with a dose of aldosterone in the morning and their blood pressure was measured every hour for 12 hours.
- This procedure was followed over four days for each individual and the average blood pressure was calculated.
- All participants followed the same diet during the period of the investigation.

3.3.1 Name the gland that secretes aldosterone. (1)

3.3.2 Identify the:

(a) Independent variable (1)

(b) Dependent variable (1)

3.3.3 Give TWO reasons why the results of the investigation may be considered reliable. (2)

3.3.4 Explain TWO reasons why it was important for the participants to follow the same diet during the investigation. (4)

3.3.5 Explain why the participants' blood pressure was measured before the start of the investigation. (2)

3.3.6 Explain why the levels of salt in the urine of participants is expected to decrease after being injected with aldosterone. (3)

(14)

- 3.4 Describe how the secretion of adrenalin causes increased energy production in an emergency situation. (8)
- 3.5 The diagram below represents the human eye.

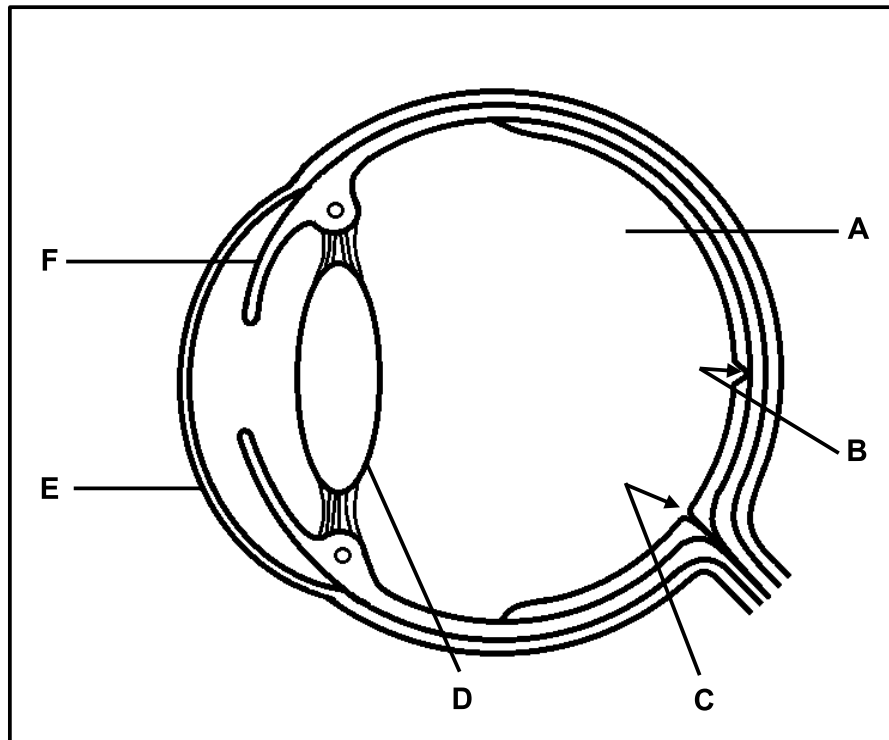

- 3.5.1 Identify structure **F**. (1)
- 3.5.2 State TWO functions of fluid **A**. (2)
- 3.5.3 Describe the structural difference between area **B** and area **C**. (2)
- 3.5.4 Name the visual defect that occurs when the curvature of part **E** is uneven. (1)
- 3.5.5 Explain how the sight of a person will be affected if cataracts developed in part **D**. (3)
- 3.5.6 Describe the process of accommodation that takes place when an object is less than 6 metres away from the eye. (6)
- (15)
[50]

TOTAL SECTION B: 100
GRAND TOTAL: 150